



7890-7891

Snipe Nose Pliers with Dual-Component Synthetic Handle





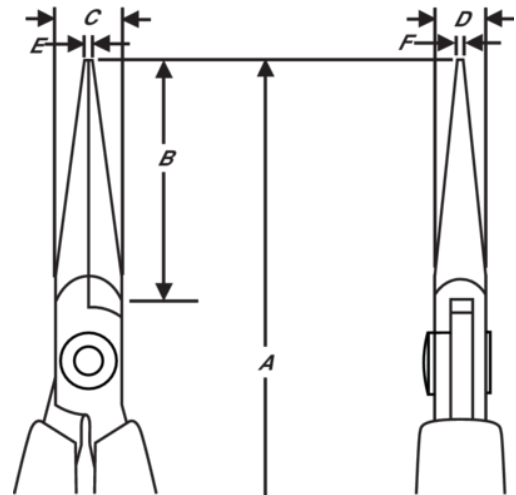

PRODUCT DETAILS

- Supreme series snipe nose pliers
- ESD safe mono-material handles with return spring
- High performance alloyed steel
- Polished finish
- Numerically controlled machine grinding guarantees accuracy & increases the tools reliability & consistency
- Tough hardened 42-46 HRC
- Screw joint that minimizes friction & maximizes jaw alignment
- 32 mm jaws with radiused edges
- CO standard handle shape in conductive material







PRODUCT ATTRIBUTES





Product: 7890

	Chain Nose		M	A	132.0 mm
A	5.20 in	B	32 mm	B	1,26 in
C	9 mm	C	0.35 in	D	6 mm
D	0,24 inch	E	1,2 mm	E	0,05 in
F	0,8 mm	F	0,03 in		Smooth
	72 g	Ω			





Product: 7891

	Chain Nose		M	A	132.0 mm
A	5.20 in	B	32 mm	B	1,26 in
C	9 mm	C	0.35 in	D	6 mm
D	0,24 inch	E	1,2 mm	E	0,05 in
F	0,8 mm	F	0,03 in		Serrated
	72 g	Ω			

Product: 7890 CO

	Chain Nose		M	A	132.0 mm
A	5.20 in	B	32 mm	B	1,26 in
C	9 mm	C	0.35 in	D	6 mm
D	0,24 inch	E	1,2 mm	E	0,05 in
F	0,8 mm	F	0,03 in		Smooth
	60 g	Ω	Conductive		

Product: 7891 CO

	Chain Nose		M	A	132.0 mm
A	5.20 in	B	32 mm	B	1,26 in
C	9 mm	C	0.35 in	D	6 mm
D	0,24 inch	E	1,2 mm	E	0,05 in
F	0,8 mm	F	0,03 in		Serrated
	59 g	Ω	Conductive		